

# Heavy-Duty LED Revolving Warning Light & Electric Horn Combination for Vessels and Heavy Industry Applications

## SHDL/ SHD2L

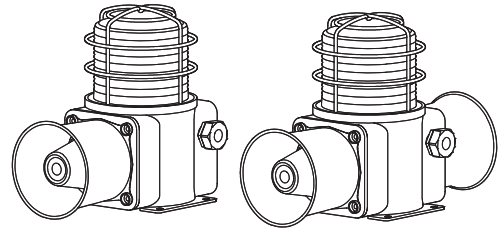

Thank you for purchasing Qlight's products. Please read this user manual carefully prior to installation and operation to ensure safe and correct use.

### ⚠️ Precautions for Safety

Failure to follow the instructions below may cause a loss of life or serious physical injury.

1. During wiring or maintenance, please completely turn off the power of the product. (Failure to follow this may lead to an electric shock.)
2. Do not install the product in locations that subjects it to excessive dust or water other than the conditions designated by the IP protection ratings indicated for each product. (Failure to follow these instructions may cause a fire to the product, electric shock, physical injury, malfunction or damage to the product.)
3. Do not alter or repair this product. If maintenance or repair service is required, please contact your local Qlight contact point. (Failure to follow these instructions may lead to fire, electric shock, or product damage.)
4. Please apply the correct voltage to the product. (Failure to follow these instructions may lead to fire, electric shock, or product damage.)
5. When the product is applied to a condition that may impact lives or property, please make sure to have a double safety device. (Failure to follow this may cause damage to property, fire, electric shock and loss of life.)

### ⚠️ Precautions for Correct Use

Failure to follow the proper instructions may cause damage to property, the product, or malfunction of the product that would void the warranty.

1. Please remove any objects that can interrupt ventilation around the product.
2. Please turn off the power of the product immediately if it fails to operate properly.
3. Carefully wire the product according to each product's specification.
4. Please be careful in preventing chemicals such as thinner, benzene, etc. in contact with the surface of the product.
5. Do not apply excessive force/impact to the product.

### Ordering Specifications

SHDL	WA	24	R
[Model number]	[Sound]	[Voltage]	[Color]
<ul style="list-style-type: none"> <li>• SHDL</li> <li>• SHD2L</li> <li>• SHDLP</li> <li>• SHD2LP</li> </ul>	<ul style="list-style-type: none"> <li>• WS-Warning sounds</li> <li>• WP-special warning sounds</li> <li>• WM-Melodies</li> <li>• WA-Alarms</li> <li>• WV-Customizable sounds</li> </ul>	<ul style="list-style-type: none"> <li>• 12 - DC12V</li> <li>• 24 - DC24V</li> <li>• 110 - AC110V</li> <li>• 220 - AC220V</li> </ul>	<ul style="list-style-type: none"> <li>R-Red</li> <li>A-Amber</li> <li>G-Green</li> <li>B-Blue</li> </ul>

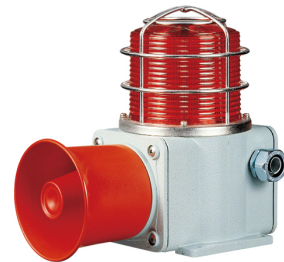

### Product Specifications

Model number	Voltage	Current	Sound pattern and volume	Certificate	Weight	Color
SHDL SHDLP	DC12V	2.511A	<ul style="list-style-type: none"> <li>• WS-5 Warning Sounds : Max.118dB</li> <li>• WP-5 special warning sounds : Max.118dB</li> <li>• WM-5 Melodies : Max.118dB</li> <li>• WA- 5 Alarms : Max.116dB</li> <li>• WV-5 Customizable sounds : Max.113dB</li> </ul>		<ul style="list-style-type: none"> <li>• SHDL DC-3.02kg</li> <li>• AC-3.39kg</li> <li>• SHDLP DC-3.27kg</li> <li>• AC-3.64kg</li> </ul>	R-Red A-Amber G-Green B-Blue
	DC24V	1.222A				
	AC110V	0.286A				
	AC220V	0.143A				
SHD2L SHD2LP	DC12V	4.722A	<ul style="list-style-type: none"> <li>• WS-Warning Sounds : Max.118dBx2</li> <li>• WP-special warning sounds : Max.118dBx2</li> <li>• WM-5 Melodies : Max.118dBx2</li> <li>• WA-5 Alarms : 116dBx2</li> <li>• WV-5 Customizable sounds : 113dBx2</li> </ul>		<ul style="list-style-type: none"> <li>• SHD2L DC-4.07kg</li> <li>• AC-4.45kg</li> <li>• SHD2LP DC-4.32kg</li> <li>• AC-4.70kg</li> </ul>	R-Red A-Amber G-Green B-Blue
	DC24V	2.188A				
	AC110V	0.513A				
	AC220V	0.256A				

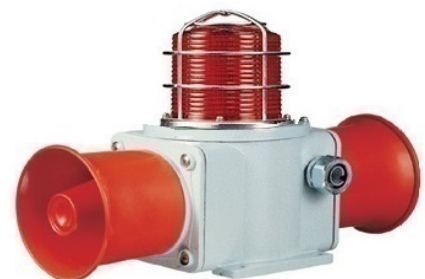

Please scan the QR code for more detailed product information.

[www.qlight.com](http://www.qlight.com)

- Protection rating : IP66
- Ambient operating temperature : -30°C to +50°C

SHDL/ SHDLP

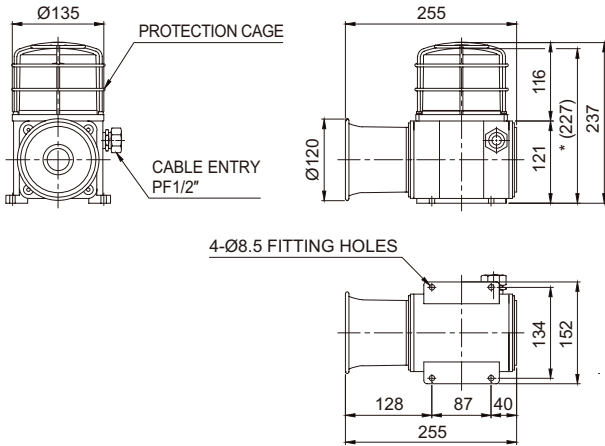

SHD2L/ SHD2LP

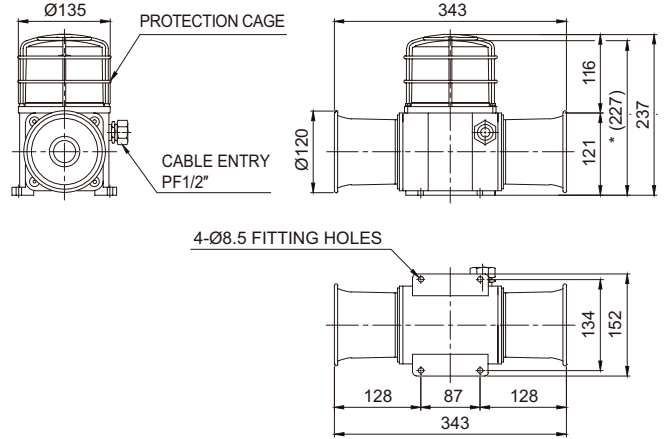

※ \*(227) represents without protection cage.

Sound Setting - Select using the switch inside of the unit.

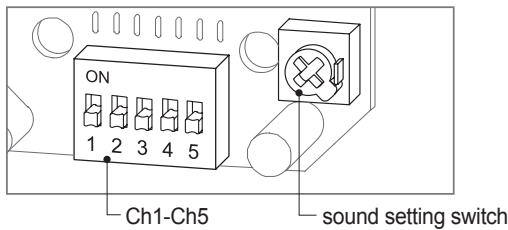

- Standard unit has 5 built-in sound tones. Select different built-in sounds using the sound setting switch.
- For standard type, once the unit is powered on, light and sound are working simultaneously.

Sound Type by Group

Category	Sound pattern	Channel	Sound tone	volume (Max.)
WS	5 Warning sounds	Ch1	Fire.A-ANG	118dB
		Ch2	Emergency WA-U	
		Ch3	Ambulance PI-PO	
		Ch4	Machinery Fault	
		Ch5	High Expansion	
WP	5 Special Warning sounds	Ch1	Fire.A-ANG	118dB
		Ch2	Abandon Alarm	
		Ch3	Machinery Fault	
		Ch4	High Expansion	
		Ch5	7 Short Pl. / 1 Long	
WM	5 Melodies	Ch1	Sweet Home	118dB
		Ch2	For Elise	
		Ch3	Cuckoo's Waltz	
		Ch4	Piano Sonata	
		Ch5	Turkish March	
WA	5 Alarms	Ch1	Beep Intermittent	116dB
		Ch2	Door Chime	
		Ch3	Phone Ring	
		Ch4	PI.PI.PI Short	
		Ch5	Tripping Beat	
WV	5 Customizable sounds	Ch1-Ch5	Available upon request (customized voice type)	113dB

Wiring Instructions for LC Type

- LC type product with exposed sound selection signal line is available upon request. Please refer to the diagram below for wiring.

SHDL/ SHDLP-DC/AC  
SHD2L/ SHD2LP-DC/AC

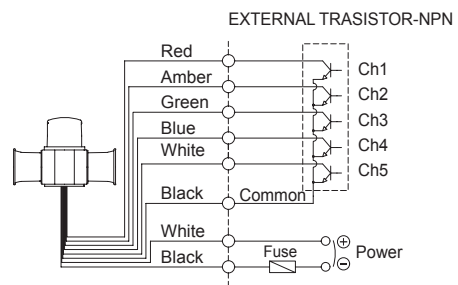
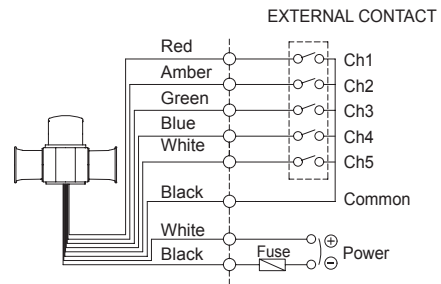

- External power line - UL1015 AWG18(0.75sq) x 2C 400mm
- External signal line - UL1007 AWG22(0.3sq) 400mm

Volume Adjustment

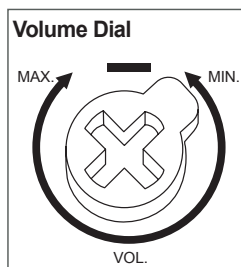

- The volume output of this product is adjustable.
- Turn the volume dial clockwise to increase the volume, and turn counter clockwise to decrease the volume.
- There will be no sound when the dial is put at MIN.

## Terminal Box Wiring Instructions

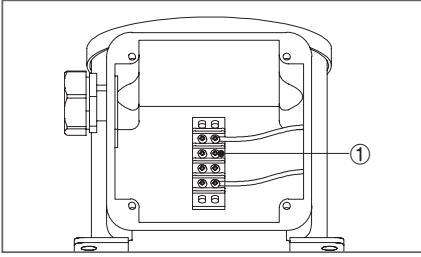

- Terminal block is located inside of the product. Unscrew the 4 bolts located in the upper body to get rid of the upper lighting element of the unit.
- Please apply fork (U-type) or ring (O-type) locking spade terminal at naked tip of the wire for secure connection.
- Please wire the power line to terminal ①
- For AC type products, wire regardless of polarity.
- For DC type products, wire terminal of black line to (-) polarity.

## Parts Definition/ Installation/ Light Function Selection/ Mounting Hole Specifications

### ■ Parts Definition/ Installation

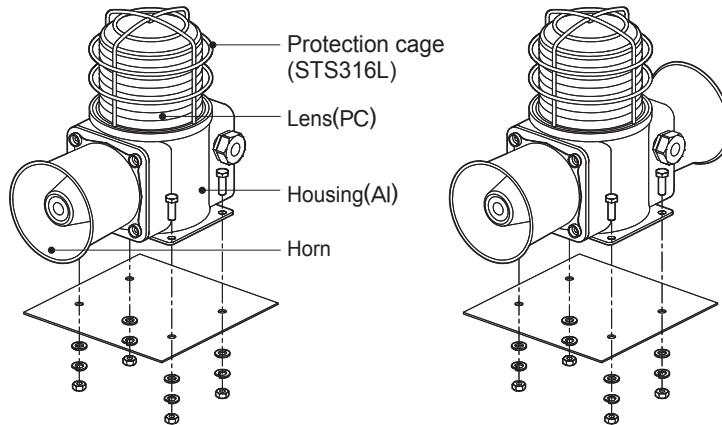

- First, machine holes on the mounting surface.
- The mounting hole of this product is 8.5mm in diameter.
- When machining taps, fasten the bolt through the mounting hole of the bracket.
- When machining holes, insert the bolt through the hole of the product, and tighten the nut from the opposite side of the mounting surface.
- When assembling using bolt and nut, please make sure to use flat washer and spring washer.

### ■ Light Function Selection

- Please refer to the chart below to use light function selection switch located inside the product.

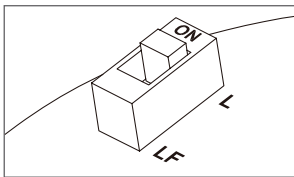

▶ L : Steady

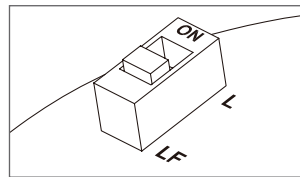

▶ LF : Flashing

- Default function is set at steady LED. Select the desired function for your application during installation.

### ■ Mounting Hole Specifications

- Machine holes on the mounting surface referring to the diagram below.

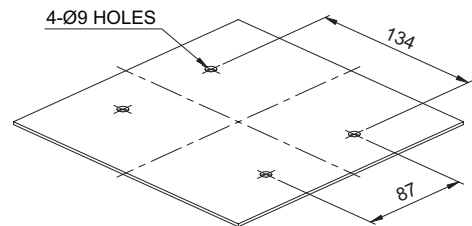

## Installation Environment and Protection Rating

- This product is designed for use with protection rating of IP66.
- If the product is installed in locations that subject it to excessive dust or water other than the designated IP protection rating indicated(IP66), it may cause malfunction or damage to the product.
- In case of outdoor applications, install the product in the upright position. Do not install the product horizontal or upside-down positions where water can potentially penetrate into the product and impact it's operation.
- For further information, please visit our website ([www.qlight.com](http://www.qlight.com)).

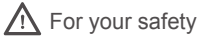

For your safety

Specification and dimensions listed in this catalogue subject to change without notice for product quality improvement.  
The newest product information is available on our website.([www.qlight.com](http://www.qlight.com))  
Please read the instruction manual attached to the product carefully before installation and use.

*Qlight Co., Ltd. [www.qlight.com](http://www.qlight.com) | [trade@qlight.com](mailto:trade@qlight.com)*

Head Office | Suite #1510, STX-V Tower, 128 Gasan digital 1-ro, Geumcheon-gu, Seoul, Korea

Tel. +82-2-2679-6152(Toll free. +82-80-328-2222) Fax. +82-2-2679-6154

Factory | 185-25, Mukbang-ro, Sangdong-myeon, Gimhae-si, Gyeongsangnamdo, Korea Tel. +82-55-328-1111(Toll free. +82-80-328-1111)

Qlight Overseas Sales Dept | 704 Nakdong-daero, Sasang-gu, Busan, Korea(Eomgung-Dong) Tel : +82-51-620-4100

Qlight Public Relations & Marketing Team Office | 704 Nakdong-daero, Sasang-gu, Busan, Korea(Eomgung-Dong) Tel. +82-51-245-0017

---

*Qlight USA, Inc. [www.qlight.com](http://www.qlight.com) [www.qlightusa.com](http://www.qlightusa.com) | [sales@qlightusa.com](mailto:sales@qlightusa.com)*

3003 North First Street, Suite #341, San Jose, CA 95134 USA Tel. +1-408-519-5740 Fax. +1-408-519-5739

---

*SHANGHAI Qlight Electronic Co., Ltd. [www.qlight.com](http://www.qlight.com) [www.qlightcn.com](http://www.qlightcn.com) | [qlightcn@qlight.com](mailto:qlightcn@qlight.com)*

China Factory/ Shanghai Sales Office | #19, Nanda Road, Baoshan Area, Shanghai, China Tel. +86-21-6651-7100 Fax. +86-21-6315-3929

**Qlight**  
Innovation in Alarm & Signal

Product Operation Inquiry / Customer Support +82-51-620-4100

You can expect prompt service if you have exact information such as model name, symptom, telephone number and address.

※ALL PRODUCT, PRODUCT SPECIFICATIONS AND DATA ARE SUBJECT TO CHANGE WITHOUT NOTICE TO IMPROVE RELIABILITY, FUNCTION OR DESIGN OR OTHERWISE.

Head office : Suite #1510, STX-V Tower, 128 Gasan digital 1-ro, Geumcheon-gu, Seoul, Korea (Postal Code : 08507)

Factory : 185-25, Mukbang-Ro, Sangdong-Myeon, Gimhae-Si, Gyeongsangnam-Do, Korea (Postal Code : 50805)

[www.qlight.com](http://www.qlight.com)